

Description

The HTH9G09P700S is an unmatched discrete LDMOS Power Amplifier with 700W saturated output power covering frequency range from 700 - 960 MHz.

Features

- Operating Frequency Range: 700 - 960 MHz
- Operating Drain Voltage: +48V
- Saturation Output Power: 700W
- Power Average: 100W
- Device can be used on a single-ended or in a push-pull configuration. Doherty application applicable
- Excellent thermal stability due to low thermal resistance package
- Enhanced robustness design without device degradation
- Efficiency: 54%@758MHz, WCDMA
- Gain: 19.5dB@758MHz, WCDMA

Applications

- 3GPP 5G NR FR1
n5/8/12/13/14/18/20/26/28/29/67/85/100
- 4G-LTE
B5/8/12/13/14/17/18/19/20/26/28/67/85/103
- Amplifier for Micro and Macro Base Stations
- Repeaters/DAS
- Mobile Infrastructure

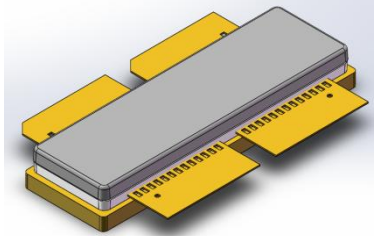



ACS3210-4L

Air Cavity Splice
Earless Flanged balanced Ceramic Package;
4 Leads

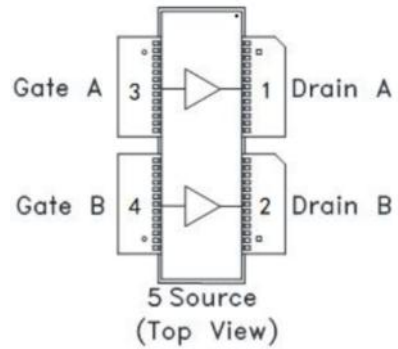

Pin Connections

Note: Exposed backside of the package is the source terminal for the transistor

Ordering Information

Part Number	Description
HTH9G09P700S	Reel Package
HTH9G09P700SEVB	758- 803 MHz EVB

Typical Performance

RF Characteristics (Pulsed CW)

Freq (MHz)	P5dB (dBm)	Gain (dB)	Eff (%)	IRL (dB)
758	59.3	20.2	53	10
780.5	59.2	20.5	53	12
803	59.2	19.9	57	15

Test conditions unless otherwise noted: 25 °C, VDD = +48Vdc, IDQ_Carrier= 450mA, Vgsp = Vgsc - 1.7V, PW = 100us, DC= 10% test on WATECH Application Board

RF Characteristics (WCDMA)

Freq (MHz)	Gain (dB)	Eff (%)	ACPR* @5MHz (dBc)	ACPR* @10MHz (dBc)	IRL (dB)
758	19.5	54.0	-24.2	-24.2	10
780.5	19.5	54.9	-25.0	-25.0	13
803	19.1	54.5	-26.9	-26.9	15

Test conditions unless otherwise noted: 25 °C, VVDD = +48Vdc, IDQ_Carrier= 450mA, Vgsp = Vgsc - 1.7V, PAVG = 49 dBm 1C-WCDMA 5MHz Signal, 9.9 dB PAR @ 0.01% CCDF test on WATECH Application Board

*Uncorrected DPD

Absolute Maximum Ratings

Parameter	Range/Value	Unit
Drain voltage (V _{DSS})	-0.5 to +110	V
Gate voltage (V _{GS})	-5 to +10	V
Storage Temperature (T _{STG})	-55 to +150	°C
Junction Temperature (T _J)	-40 to +225	°C

Electrical Specification

DC Characteristics (Carrier)

Parameter	Conditions	Min	Typ	Max	Unit
Breakdown Voltage $V_{(BR)DSS}$	$V_{gs}=0V, I_{ds}=180\mu A$	110	-	-	V
Gate-Source Threshold Voltage $V_{GS(th)}$	$V_{gs}=10V, I_{ds}=180\mu A$	-	2.7	-	V
Drain Leakage Current I_{DSS}	$V_{gs}=0V, V_{ds}=110V$	-	-	500	nA
Gate Leakage Current I_{GSS}	$V_{gs}=10V, V_{ds}=0V$	-	-	500	nA

DC Characteristics (Peak)

Parameter	Conditions	Min	Typ	Max	Unit
Breakdown Voltage $V_{(BR)DSS}$	$V_{gs}=0V, I_{ds}=360\mu A$	110	-	-	V
Gate-Source Threshold Voltage $V_{GS(th)}$	$V_{gs}=10V, I_{ds}=360\mu A$	-	2.7	-	V
Drain Leakage Current I_{DSS}	$V_{gs}=0V, V_{ds}=110V$	-	-	500	nA
Gate Leakage Current I_{GSS}	$V_{gs}=10V, V_{ds}=0V$	-	-	500	nA

Load Mismatch Test

Condition	Test Result
VSWR=10:1, at all Phase Angles, VDD = +48Vdc, IDQ_Carrier= 450mA, Vgsp = Vgsc - 1.7V, 1C-WCDMA 5MHz Signal, 9.9 dB PAR, PAVG = 52 dBm, Frequency 780.5 MHz test on WATECH Application Board	No Device Degradation

Thermal Information

Parameter	Condition	Value (Typ)	Unit
Thermal Resistance Junction to Case (R_{TH})	$T_{CASE}= 80^{\circ}C, VDD = +48Vdc,$ $IDQ_Carrier= 450mA, Vgsp = Vgsc - 1.7V,$ 1C-WCDMA 5MHz Signal, 9.9 dB PAR, $PAVG = 53 dBm$	0.46	$^{\circ}C /W$



Load Pull Performance Carrier

Test conditions unless otherwise noted: 25 °C, VDD = +48Vdc, IDQ= 450mA, PW = 100us, DC= 10%

Max Output Power (Carrier)						
Freq (MHz)	Z_source (Ω)	Z_load [1] (Ω)	Gain (dB)	P3dB (dBm)	P3dB (W)	Eff (%)
760	3.5-j*1.5	1.9+j*0.2	22.6	55.5	360	69.0
860	3.8-j*4.7	1.7+j*0.12	21.7	55.4	350	68.0
960	7.3-j*8.9	1.5-j*0.4	20.5	55.3	340	63.0

[1] Load impedance for optimum P3dB pout

Max Drain Efficiency (Carrier)						
Freq (MHz)	Z_source (Ω)	Z_load [2] (Ω)	Gain (dB)	P3dB (dBm)	P3dB (W)	Eff (%)
760	3.5-j*1.5	1.5+j*1.7	24.5	53.6	230	77.0
860	3.8-j*4.7	1.4+j*1.3	23.5	53.7	235	75.0
960	7.3-j*8.9	1.3+j*0.8	22.3	54.0	255	71.2

[2] Load impedance for optimum P3dB efficiency

Load Pull Performance Peak

Test conditions unless otherwise noted: 25 °C, VDD = +48Vdc, IDQ= 700mA, PW = 100us, DC= 10%

Max Output Power (Peak)						
Freq (MHz)	Z_source (Ω)	Z_load [1] (Ω)	Gain (dB)	P3dB (dBm)	P3dB (W)	Eff (%)
760	1.7-j*0.8	0.8+j*0.7	22.3	58.1	650	65.5
860	1.9-j*2.1	0.8+j*0.5	21.5	58.0	640	64.0
960	3-j*4.5	0.8+j*0.0	20.2	57.9	620	61.0

[1] Load impedance for optimum P3dB pout

Max Drain Efficiency (Peak)						
Freq (MHz)	Z_source (Ω)	Z_load [2] (Ω)	Gain (dB)	P3dB (dBm)	P3dB (W)	Eff (%)
760	1.7-j*0.8	1.1-j*0.0	24.0	57.0	498	75.0
860	1.9-j*2.1	0.9-j*0.1	23.2	56.5	455	72.0
960	3-j*4.5	0.9-j*0.2	22.0	56.5	450	69.0

[2] Load impedance for optimum P3dB efficiency

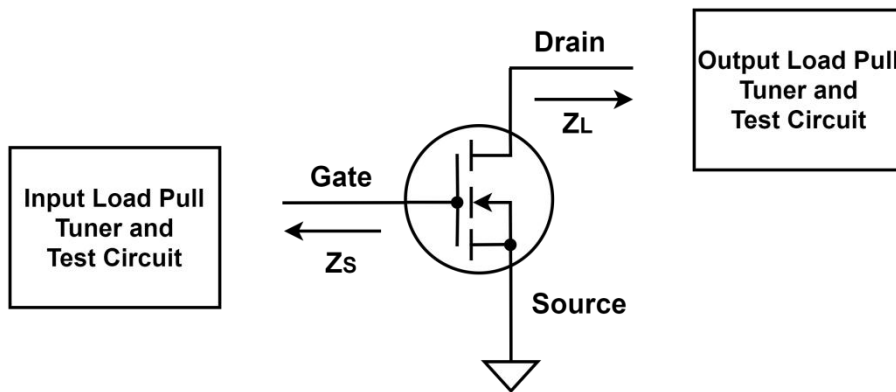

Z_{source} : Measured impedance presented to the input of the device at the package reference plane

Z_{load} : Measured impedance presented to the output of the device at the package reference plane

HTH9G09P700S 925- 960 MHz Reference Design

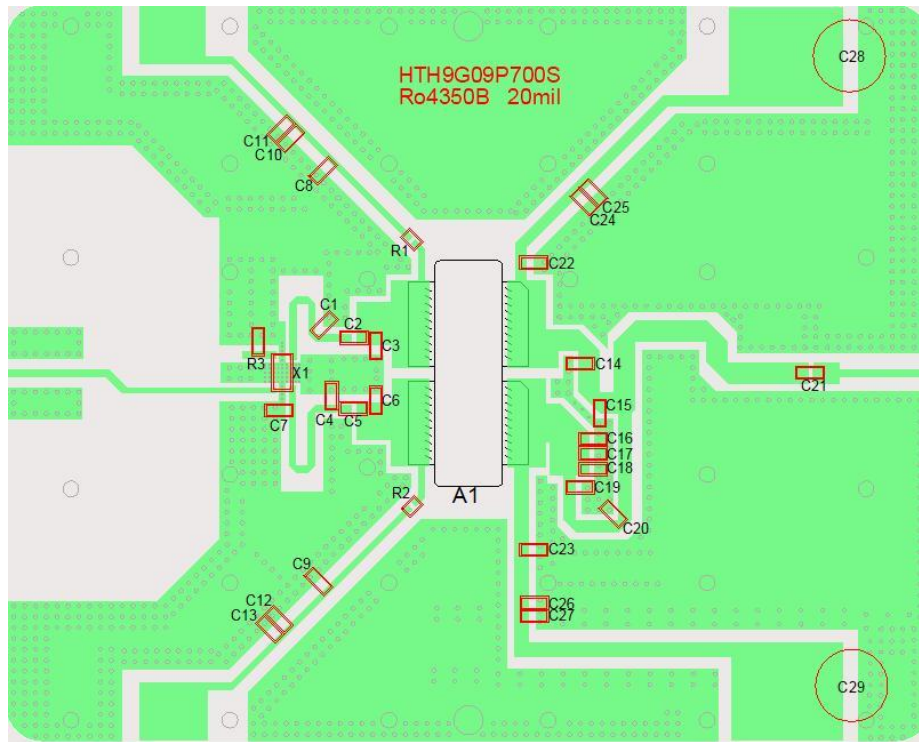

EVB Layout

Bill of Materials (BoM) - HTH9G09P700S

925- 960 MHz Reference Design

Reference	Value	Description	Manufacturer	P/N
Q1	-	700W, 700 - 960 MHz LDMOS PA	Watech	HTH9G09P700S
C2,C5,C8,C9,C21, C22,C23	56pF	MLCC	Murata	GQM2195C2E560JB12
C1,C14	12pF	MLCC	Murata	GQM2195C2E120JB12
C3	7p5F	MLCC	Murata	GQM2195G2E7R5BB12
C4,C16	11pF	MLCC	Murata	GQM2195C2E110JB12
C6	15pF	MLCC	Murata	GQM2195C2E150JB12
C7	2pF	MLCC	Murata	GQM2195G2E2R0BB12
C15,C19	6p2F	MLCC	Murata	GQM2195G2E6R2BB12
C17	10pF	MLCC	Murata	GQM2195C2E100JB12

Reference	Value	Description	Manufacturer	P/N
C18	9p1F	MLCC	Murata	GQM2195G2E9R1BB12
C20	3p9F	MLCC	Murata	GQM2195G2E3R9BB12
C10,C12	1uF /100V	MLCC	Murata	GRM32CR72A105KA35
C11,C13	4u7F /100V	MLCC	Murata	GRM32DC72A475ME01
C24,C25,C26, C27	10uF /100V	MLCC	Murata	GRM32EC72A106KE05
C28,C29	220uF /100V	Electrolytic Capacitor	Vishay	MAL213669221E3
R1, R2	10Ω	Thick Film Resistor	YAGEO	RC0805FR-0710RL
R3	50Ω/ 25W	High Frequency/RF Resistors	ANAREN	C16A50Z4
X1	-	Hybrid Coupler 2dB, 90°	ANAREN	X3C07F1-02S
PCB	Rogers 4350B (er = 3.66), 20 mil (0.508 mm), 35 μm (1oz)			

Performance Plots

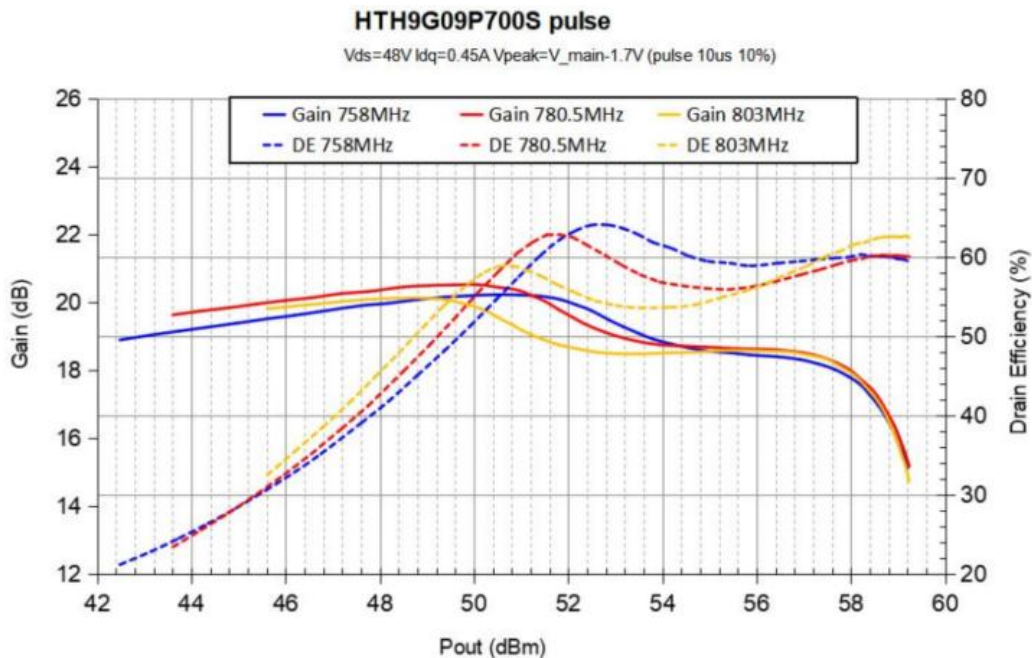

Pulsed CW, Gain and Efficiency vs Pout

Test conditions unless otherwise noted: 25 °C, VDD = +48Vdc, IDQ= 450mA, Vgsp = Vgsc - 1.7V, PW = 100us, DC= 10% test on WATECH Application Board

HTH9G09P700S WCDMA

V_{ds}=48V I_{dq}=0.45A V_{peak}=V_{gs_c}-1.7V (WCDMA 5MHz)

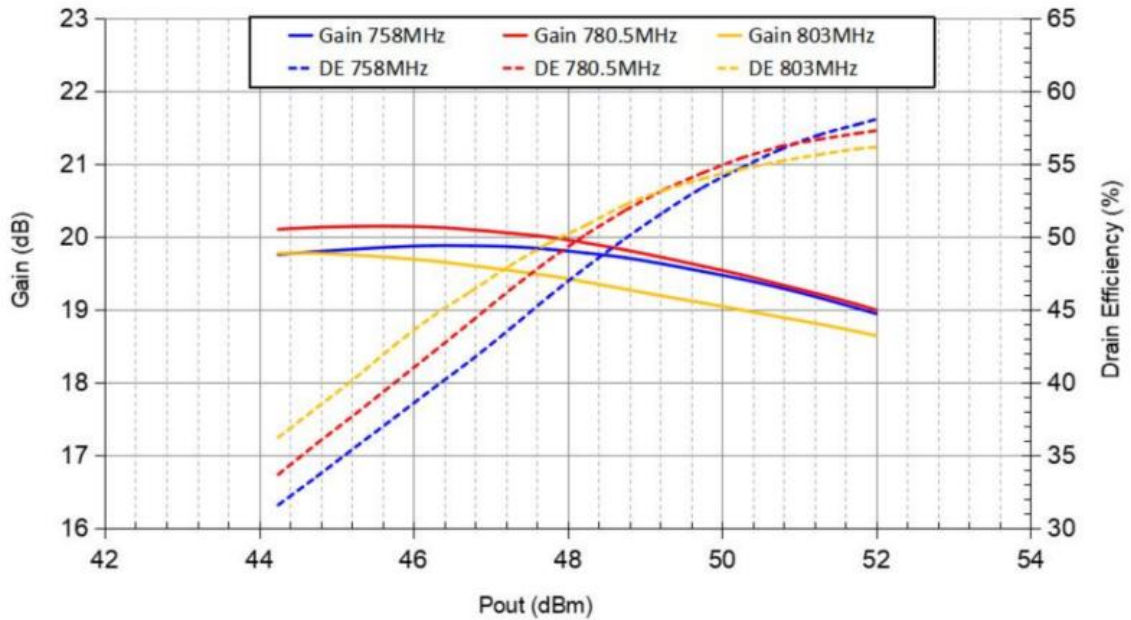

WCDMA, Gain and Efficiency vs Pout

Test conditions unless otherwise noted: 25 °C, V_{DD} = +48Vdc, I_{DQ} = 450mA, V_{gsp} = V_{gsc} - 1.7V, 1C-WCDMA 5MHz Signal, 9.9 dB PAR @ 0.01% CCDF test on WATECH Application Board

HTH9G09P700S WCDMA

V_{ds}=48V I_{dq}=0.45A V_{peak}=V_{gs_c}-1.7V (WCDMA 5MHz)

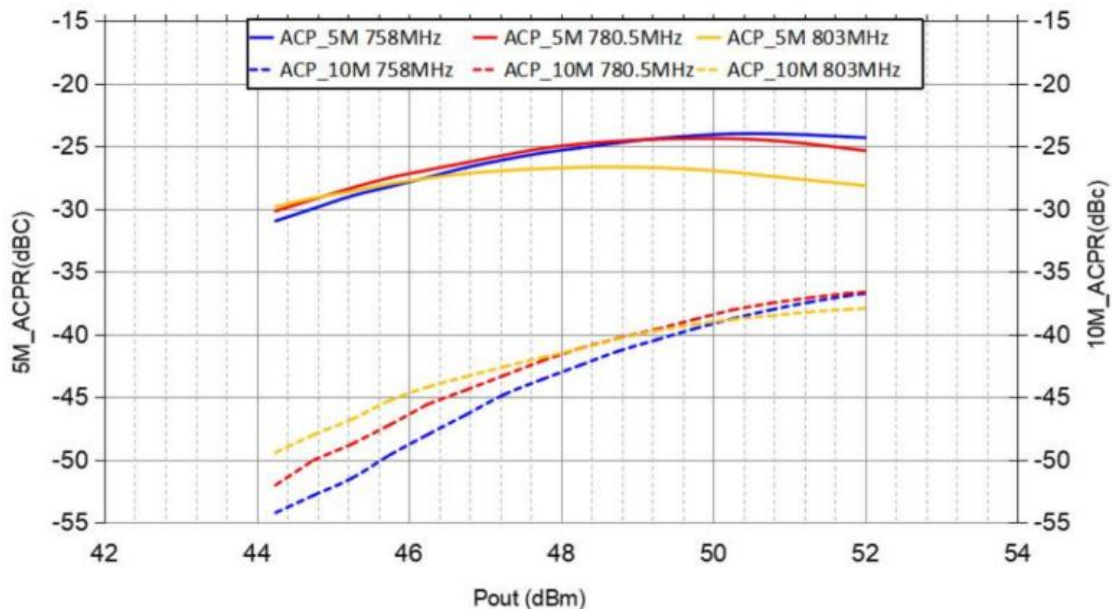

WCDMA, ACPR_5MHz, ACPR_10MHz vs Pout

Test conditions unless otherwise noted: 25 °C, V_{DD} = +48Vdc, I_{DQ} = 450mA, V_{gsp} = V_{gsc} - 1.7V, 1C-WCDMA 5MHz Signal, 9.9 dB PAR @ 0.01% CCDF test on WATECH Application Board

Package Marking and Dimensions

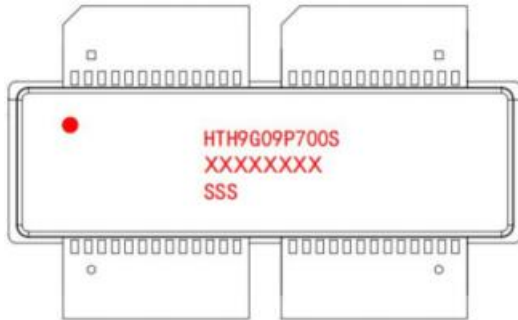

- Line1 (fixed): Device name in W/O
 - Line2 (unfixed): Marking Lot No in W/O (Sample: E596-20140001)
 - Line3 (unfixed): Date Code + JY
- This Marking SPEC only stipulates the content of Marking. For marking requirements such as font and size, please refer to the latest version of "Watech Product Printing Specification"

Marking

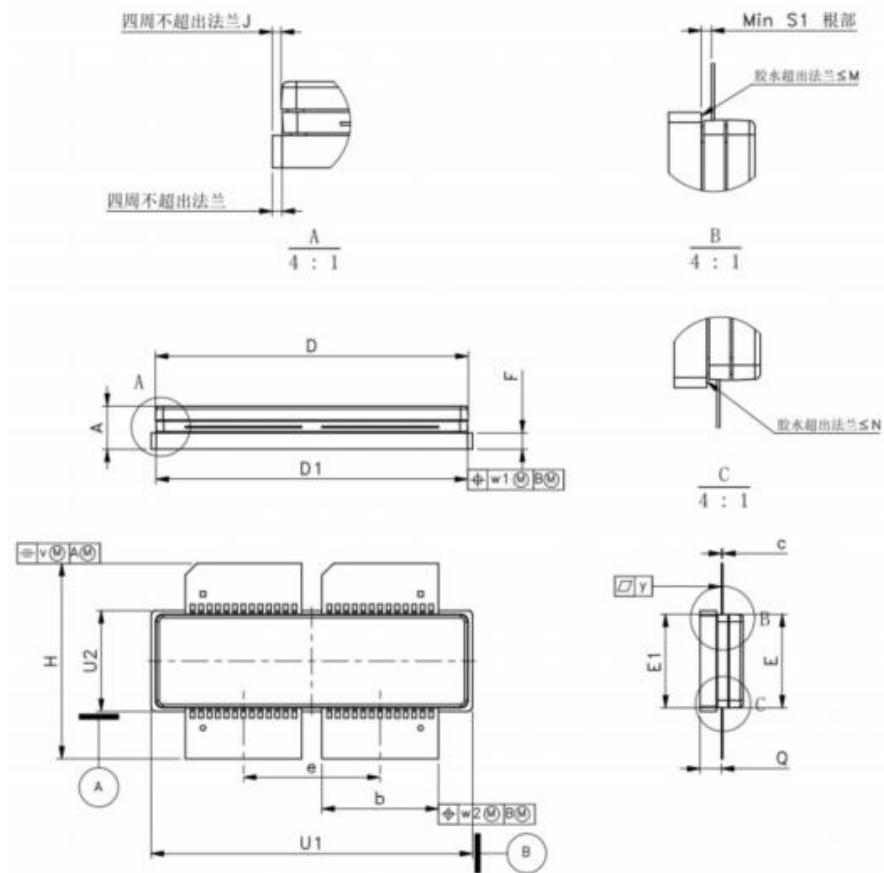

Unit	A	b	c	D	D1	E	E1	e	F	H	Q	
mm	max	4.52	11.78	0.17	31.54	31.34	9.60	9.50		1.73	19.71	2.24
	nom								13.71			
	min	4.12	11.58	0.13	31.14	31.14	9.20	9.30		1.53	19.51	2.04
Unit	U1	U2	J	S1	M	N	v	w1	w2	y		
mm	max	32.33	10.23									
	nom			0.1	0.5	0.02	0.1	0.5	0.5	0.5	0.1	
	min	32.13	10.03									

Package Dimensions

Tape and Reel Information

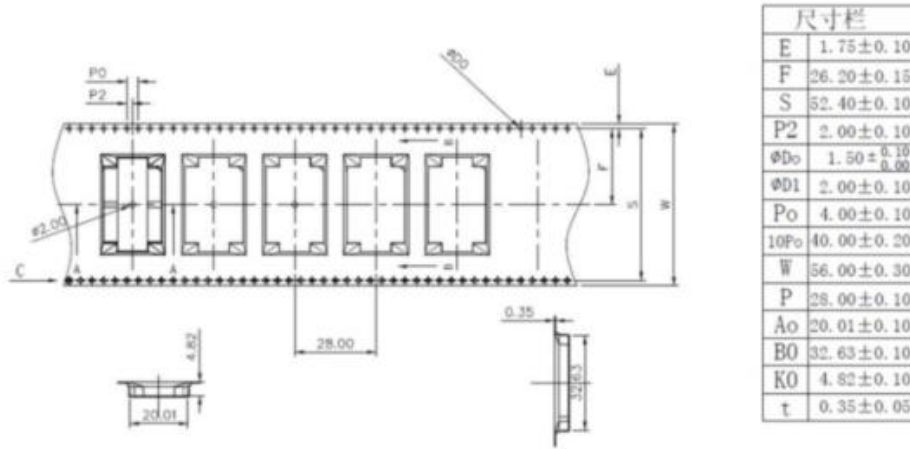

TBD

Tape & Reel Packaging Descriptions

Handling Precautions

Parameter	Grade
Moisture Sensitivity Level MSL	3

Parameter	Rating	Standard	
ESD – Human Body Model (HBM)	Class 1B	JESD22-A114	
ESD – Human Body Model (MM)	Class A	EIA/JESD22-A115	
ESD – Charged Device Model (CDM)	Class III	JESD22-C101	

RoHS Compliance

This product is compliant with the 2011/65/EU RoHS directive (Restrictions on the Use of Certain Hazardous Substances in Electrical and Electronic Equipment), as amended by Directive 2015/863/EU.

Datasheet Status

Document status	Product status	Definition
Objective Datasheet	Design simulation	Product objective specification
Preliminary Datasheet	Customer sample	Engineering samples and first test results
Product Datasheet	Mass production	Final product specification

Abbreviations

Acronym	Definition
LDMOS	Laterally-Diffused Metal-Oxide Semiconductor
CW	Continuous Waveform

Revision history

Document ID	Datasheet Status	Release Date	Revision Version
Rev 1.0	Preliminary	Dec. 2021	Pre-release version
Rev 1.1	Preliminary	Dec. 2021	Update fin order codes
Rev 1.2	Preliminary	Feb. 2022	Supplementary BOM information
Rev 1.3	Product	April 2022	
Rev 1.4	Product	April 2022	Update company logo and English name
Rev 1.5	Product	April 2022	Update BOM
Rev 1.6	Product	March 2023	New format based on English version datasheet



HTH9G09P700S

700W, 700 - 960 MHz LDMOS Amplifier

Product datasheet

Contact Information

For the latest specifications, additional product information, worldwide sales and distribution locations and information about WATECH:

- Web: www.watechelectronics.com
- Email: MKT@huatai-elec.com

For technical questions and application information:

- Email: MKT@huatai-elec.com

Important Notice

Information in this document is believed to be accurate and reliable. However, WATECH does not give any representations or warranties, expressed or implied, as to the accuracy or completeness of such information and shall have no liability for the consequences of use of such information.

“Typical” parameters are the average values expected by WATECH in large quantities and are provided for information purposes only. All information and specifications contained herein are subject to change without notice and customers should obtain and verify the latest relevant information before placing orders for WATECH products.

The information contained herein or any use of such information does not grant, explicitly or implicitly, to any party any patent rights, licenses, or any other intellectual property rights, whether with regard to such information itself or anything described by such information.

Applications that are described herein for any of these products are for illustrative purposes only. WATECH makes no representation or warranty that such applications will be suitable for the specified use without further testing or modification. Customers are responsible for the design and operation of their applications and products using WATECH products, and WATECH accepts no liability for any assistance with applications or customer product design. It is customer's sole responsibility to determine whether the WATECH product is suitable and fit for the customer's applications and products planned, as well as for the planned application and use of customer's third-party customer(s). Customers should provide appropriate design and operating safeguards to minimize the risks associated with their applications and products.

WATECH products are not designed, authorized or warranted to be suitable for use in life support, life-critical or safety-critical systems or equipment, nor in applications where failure or malfunction of a WATECH product can reasonably be expected to result in personal injury, death or severe property or environmental damage. This document as well as the item(s) described herein may be subject to export control regulations. Export might require a prior authorization from competent authorities.